

Borneo Lute ‘Sape’: The Frequency Spectrum and Time Frequency Analysis (TFA)

Sinin Hamdan,^{a,*} Khairul Anwar Mohamad Said,^a Md Rezaur Rahman,^a Marini Sawawi,^a and Aaliyawani Ezzerin Sinin^b

Sound elements were studied for a six strings sape, a traditional instrument. The frequency was evaluated using a frequency spectrum and a time frequency plane. PicoScope oscilloscopes and Adobe Audition version 3 were used to record the acoustic spectra. Fast Fourier Transform (FFT) analysis was used for the Fourier spectra (using PicoScope) and time frequency analysis (TFA) spectrograms (using Adobe Audition). The Fourier spectra identified the partial frequencies up to 10th overtone. The sape have an acoustic spectrum pattern with a constant harmonic overtone. Open strings 1 through 6 have notes F3, F3, A3, Bb3, G3, and C4, respectively. String 1 has 17 frets. Strings 2 through 6 are for drone purposes with no fret. The open string 1 and frets 1 through 17 have notes F3, G3, A3, Bb3, C4, D4, E4, F4, G4, A4, Bb4, C5, D5, E5, F5, G5, A5, and C6. String 1 has 2 octaves in the F major key with a jumping note in the third octave, which consists of F5, G5, A5, and C6 only.

DOI: 10.15376/biores.18.4.6761-6771

Keywords: Acoustic spectra; Frequency spectrum; Harmonic overtone; Time frequency analysis; Sape instrument classification

Contact information: a: Faculty of Engineering, Universiti Malaysia Sarawak, 94300 UNIMAS, Kota Samarahan, Sarawak, Malaysia; b: Department of Science and Technology, Faculty of Humanities, Management and Science, Universiti Putra Malaysia, Bintulu Campus, 97008 Bintulu, Sarawak, Malaysia; *Corresponding author:hsinin@unimas.my

INTRODUCTION

Sarawak, Malaysia has many local musical instruments. One popular traditional musical instrument is the sape. A sape is a traditional lute of the Kenyah and Kayan community. It is a plucked string instrument, carved from one piece of wood with a neck and frets. It is made from light hardwood from merdang (*Cinnamomum porrectum*) under the family Lauraceae with a density of 350 to 880 kg/m³. It can also be from a light hardwood meranti from the tropical *Shorea* tree species with a density of 415 to 885 kg/m³. The wood is carved and functions as a resonator. The traditional sape has three or four strings, while the modern sape has 6 strings.

Traditionally, sape is played for ritualistic music to induce trance, but it is also used in concerts for entertainment purposes. This work studies the pitch and partial frequency of the sape strings and the function of the fret. The study can be a reference for the sape player and manufacturer. Most researchers have studied the frequency characteristics of the sape instruments (Wong *et al.* 2017, 2022; Wong and Dayou 2019). A typical musical tone is made of many harmonics. The harmonic ratios are 1: 2: 3: 4: 5, *etc.* Musical sound gives a single note (single definite pitch, also called the fundamental frequency) and timbre, depending on the harmonic amplitude. The sum of sinusoidal components or harmonic

partial form a complex tone (Plomp 1976). In a musical context, the human ear cannot identify the partials by listening to the tones; *i.e.*, the ear cannot distinguish the individual harmonics (Plomp 1976). This work investigated the pure tone signal and TFA. The signals from PicoScope Oscilloscope yield amplitude-frequency, which identify the pitch. PicoScope only measures the pitch, while Adobe Audition detects the time frequency analysis (TFA), which involves time and frequency utilising Fourier analysis. Figure 1 shows the modern sape with 6 strings used in this study.



Fig. 1. The front and back view of modern sape with 6 strings

The signal was captured using Adobe Audition, showing the time frequency content. The spectra give the pitch which is based on the equal tempered scale (ETS). The musical signals reveal many features (Herrera-Boyer *et al.* 2003, 2006; Essid *et al.* 2006; Klapuri and Davy 2006; Deng *et al.* 2008). The spectrum based on the FFT showed the temporal evolution, which characterises the spectral features on a time basis. The TFA shows the partial frequency that varies with time are separated into two cases. The first case emphasizes instantaneous frequency from the sinusoidal wave using FFT (amplitude *versus* frequency), called frequency modulation. The second case emphasizes TFA. Pitch

frequency features have been used for musical instruments (Lin *et al.* 2005). Due to the nature of music, this article represents the signals using time frequency features, which are effective where time varying frequency distinguish the timbre. The sape instrument is an example for which harmonics and subharmonics frequency determine the note. This is critical because only a professional sape player knows what is considered as good sound. Thus, there is a need for evident not only from hearing, because an ordinary person will not recognize proper pitch according to a musician's ear. Knowing how to select a sape based on the fundamental and harmonic of each sape can assist parents, novices, and sape instructors.

The experimental data were collected using Adobe Audition. It was analysed as the frequency in TFA. This will classify the sape with good sound. The non-stationary nature of musical signals is exploited to generate the frequency spectrum. It is common to classify musical instrument sounds based on frequency spectrum features, which only display the frequency information available in the signal. The time varying frequency constituted of fundamental and harmonic frequencies. The time and frequency had proven successful for the classification of audio and musical instruments (Lin *et al.* 2005; Essid *et al.* 2006; Deng *et al.* 2008; Wieczorkowska and Kubera 2009).

EXPERIMENTAL

The experiment was conducted in the anechoic room at UNIMAS Music Department. The sound was collected using a microphone. The voltage-time signal and the amplitude frequency spectrogram were recorded by PicoScope Oscilloscope. The TFA was performed with Adobe Audition, based on the distinct intensity in hertz (differentiates the strength of the partial frequencies) with magnitudes in second. Most sound analysis and re-synthesis investigate tone systems with this approach. (Hamdan *et al.* 2020; Hamdan *et al.* 2021; Hamdan *et al.* 2023) The 1st to 10th partial for each sting were plotted for comparison purposes. For sound recording, the microphone was arranged to be aligned with the sape string at a distance below 20 cm (see Fig. 2).

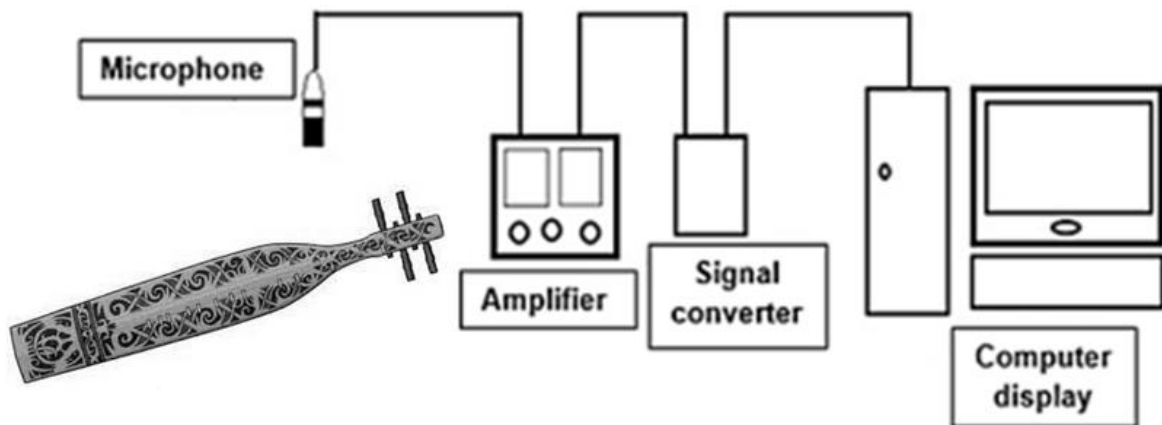

Fig. 2. The experimental setup for the microphone method

To ensure an identical plucking pattern, an expert player was hired. The format for the recorded audio signal is a mono 24-bit resolution with a sampling rate of 48 kHz. The

audio profile was saved in .wav format for further processing. Before recording the session, a calibration was carried out to ensure optimum setting.

The method based on European Broadcasting Union (EBU) was adopted for the calibration procedure with the test tone limited to 1 kHz sine wave. According to EBU, the digital equivalent of 0 VU recorded by the device must be generated at +4 dBu or -18 dBFS in either analog or digital format. During the calibration procedure, no other device was present that may boost or attenuate the signal amplitude. The recording system setup was made of audio interfaces (Steinberg UR22mkII), a microphone (Audio-Technica AT4050), an amplifier (Behringer Powerplay Pro XL, Behringer, China), and cable (XLR) with the microphone arranged to low cut (flat). For audio processing, the signal is logged by oscilloscopes (Pico Technology, 3000 series, Eaton Socon, UK) and is analyzed by PicoScope software (ver. 6), especially on FFT, voltage-based trigger and spectrum analysis.

RESULTS AND DISCUSSION

FFT determines the fundamentals, harmonics, and subharmonics. Each string showed all the partial frequencies at a particular time, which distinguished the harmonics or subharmonics. The frequencies do not yield information about time localisation. The localised frequency versus time can be identified by TFA which give frequency (in Hz) and time (in second) plane. The red and yellow region in TFA showed intensity (frequency) versus time. The partial frequencies are displayed as distinct peaks. On the y-axis the individual frequency is clearly separated and divided into line segments that corresponds to the fundamentals and overtones in each string. The research visualised the sound sonically using PicoScope oscilloscopes and Adobe Audition. The typical frequency spectrum of the individual string obtained from PicoScope is shown in Fig. 3.

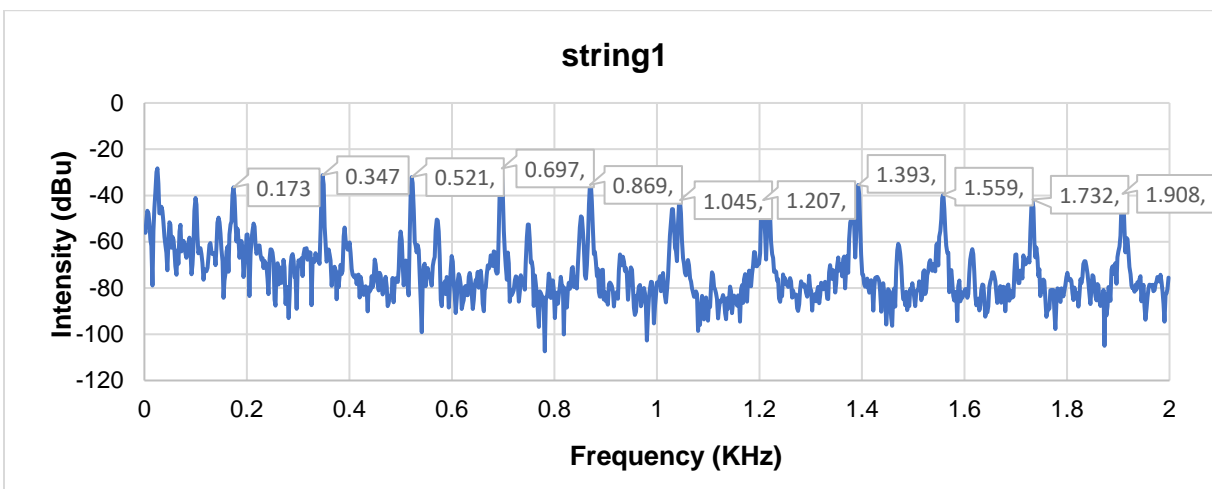

Fig. 3. The typical frequency spectrum from string 1

The pitches and overtones of the partial of string 1, 2, 3, 4, 5, and 6 are shown in Table 1. The open string and its higher note with 17 frets from string 1 are shown in Table 2. Figure 4 shows the partial frequency of strings 1, 2, 3, 4, 5, and 6.

Table 1. The Pitches and Octave of the Partial of Strings 1, 2, 3, 4, 5 and 6

String1 F3=174hz		String2 F3=174hz		String3 A3=220hz		String4 A3#=233hz		String5 G3=196hz		String6 C4=261hz	
freq	overtone	freq	overtone	freq	overtone	freq	overtone	freq	overtone	freq	overtone
173	1	175	1	222	1	232	1	195	1	259	1
347	2.00	349	1.99	443	1.99	464	2	390	2	355	1.37
523	3.02	523	2.98	667	3.00	695	2.99	585	3	521	2.01
572	3.30	873	4.98	886	3.99	927	3.99	783	4.01	615	2.37
697	4.02	1044	5.96	1117	5.03	1215	5.23	867	4.44	783	3.02
750	4.33	1201	6.86	1337	6.02	1392	6	976	5.00	876	3.38
869	5.02	1394	7.96	1548	6.97	1625	7.00	1171	6.00	1560	6.02
1042	6.02	1554	8.88	1777	8.00	1857	8.00	1259	6.45	1820	7.02
1218	7.04	1904	10.88			1912	8.24	1371	7.03	1917	7.40
1392	8.04							1455	7.46		
1558	9.00							1564	8.02		
1732	10.01							1648	8.45		
1908	11.02							1763	9.04		

Table 2. The 1st Partial until the 10th Partial of the 17 Frets from String 1 (Open String 1 Has Frequency 173Hz (F3=174Hz))

fret	1 st (note)	2 nd (note)	3 rd	4 th	5 th	6 th	7 th	8 th	9 th	10 th
1	196(G3=196)	396(G4=392)	595	794	996	1207	1406	1591	1729	1992
2	218(A3=220)	439(A4=440)	660	878	1130	1541	1796	1986		
3	232(A3#=233)	464(A4#=466)	695	931	1201	1394	1628	1673	1861	
4	261(C4=261)	519(C5=523)	781	1304	1384	1564	1648	1828	1910	
5	294(D4=294)	587(D5=587)	880	1175	1349	1466	1648	1763		
6	328(E4=329)	656(E5=659)	984	1314	1367	1640	1699	1970		
7	347(F4=349)	697(F5=698)	851	1046	1203	1396	1551	1744	1904	
8	392(G4=392)	785(G5=783)	1177	1242	1570	1640				
9	439(A4=440)	880(A5=880)	904	1324	1349	1763	1791			
10	468(A4#=466)	935(A5#=932)	1181	1402	1656	1875				
11	525(C5=523)	1052(C6=1046)	1361	1580	1894					
12	591(D5=587)	1183(D6=1174)	1626	1775						
13	667(E5=659)	1333(E6=1318)								
14	699(F5=698)	1396(F6=1396)	1898							
15	796(G5=784)	1603(G6=1568)								
16	880(A5=880)	1765(A6=1760)								
17	1046(C6=1046)									

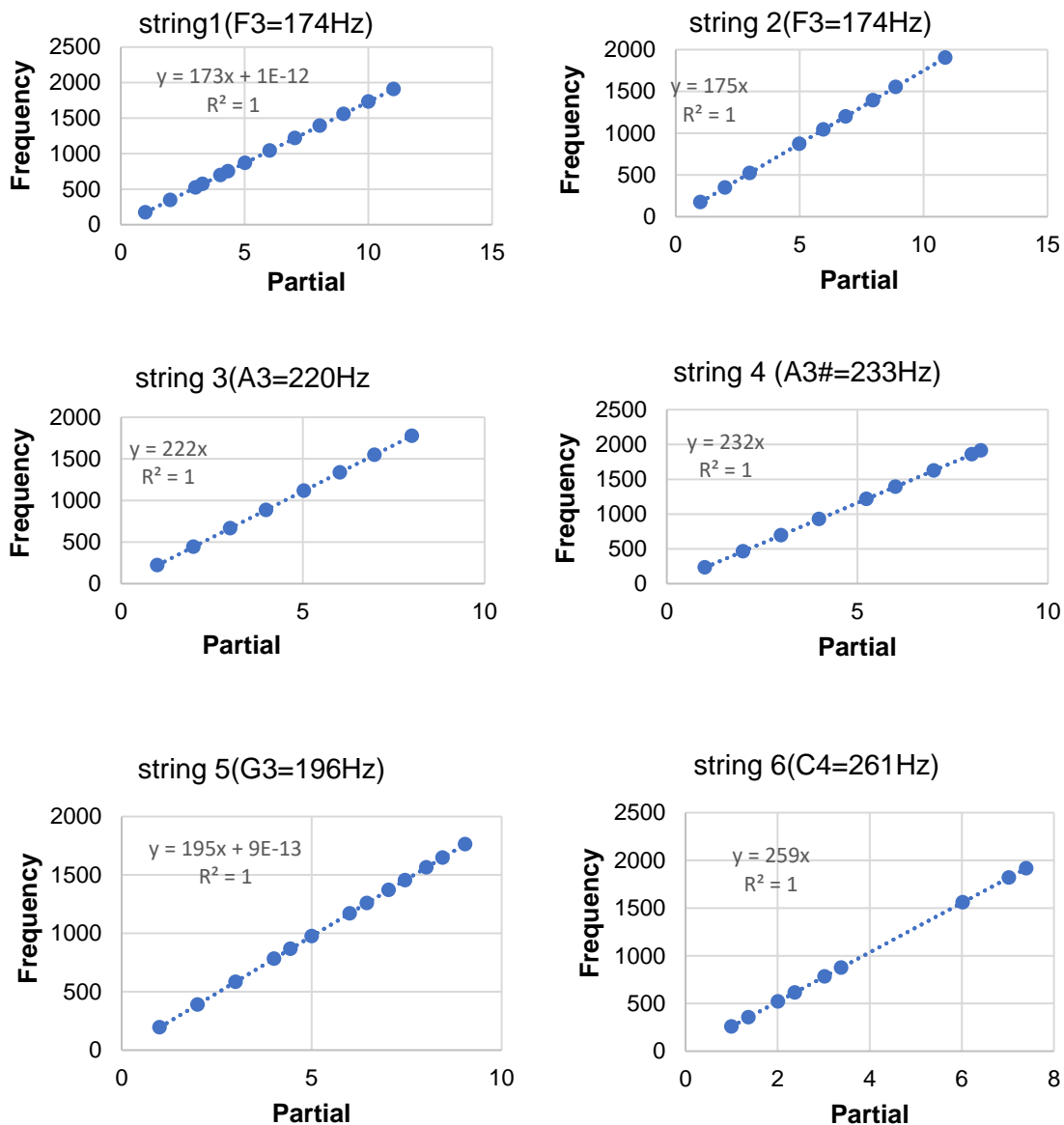

Fig. 4. The partial frequency of the individual harmonic of string 1, 2, 3, 4, 5, and 6

From Table 1, the open strings 1, 2, 3, 4, 5, and 6 were F3(174Hz), F3(174Hz), A3(220Hz), A3#(233Hz), G3(196Hz), and C4(261Hz), respectively. From Table 2, the first fundamental partials for fret 1 to 17 were 196, 218, 232, 261, 294, 328, 347, 392, 439, 468, 525, 591, 667, 699, 796, 880, and 1046 Hz, which is equivalent to the note G3, A3, B3b, C4, D4, E4, F4, G4, A4, B4b, C5, D5, E5, F5, G5, A5, and C6. Figure 5 shows the partials frequency versus time (TFA) from Adobe Audition for strings 1 through 6. The TFA explains the sound as the frequency range (in Hz) on the vertical axis over time (in second). Figure 6 shows the partials frequency versus time (TFA) for frets 1 through 17. Figure 6 shows distinct peaks which correspond to the partials of each fret where the dominant frequency is clearly separated and divided into line segments. As the fret number

increased the partial frequency became less and more distinct. Only the first fret had 10 partials, and the number of partial decreased with fret number as shown in Table 2.

The red region showed intensity of the frequency versus time. The partial frequencies are displayed as distinct peaks (larger values displayed darker). From TFA, string 2 highlight more significant dominant frequency than string 1. For string 3, 4, 5, and 6 the y-axis showed the individual frequency is clearly separated and divided into line segments that corresponds to the partials in each note. TFA provides red part which explains frequency intensity range stated on the vertical axis. PicoScope only display the frequency at a particular time. Adobe Audition spectrograms can detect the frequency which is not possible by mother's nature hearing because human ear cannot discriminate sound wave in 0.5 second interval.

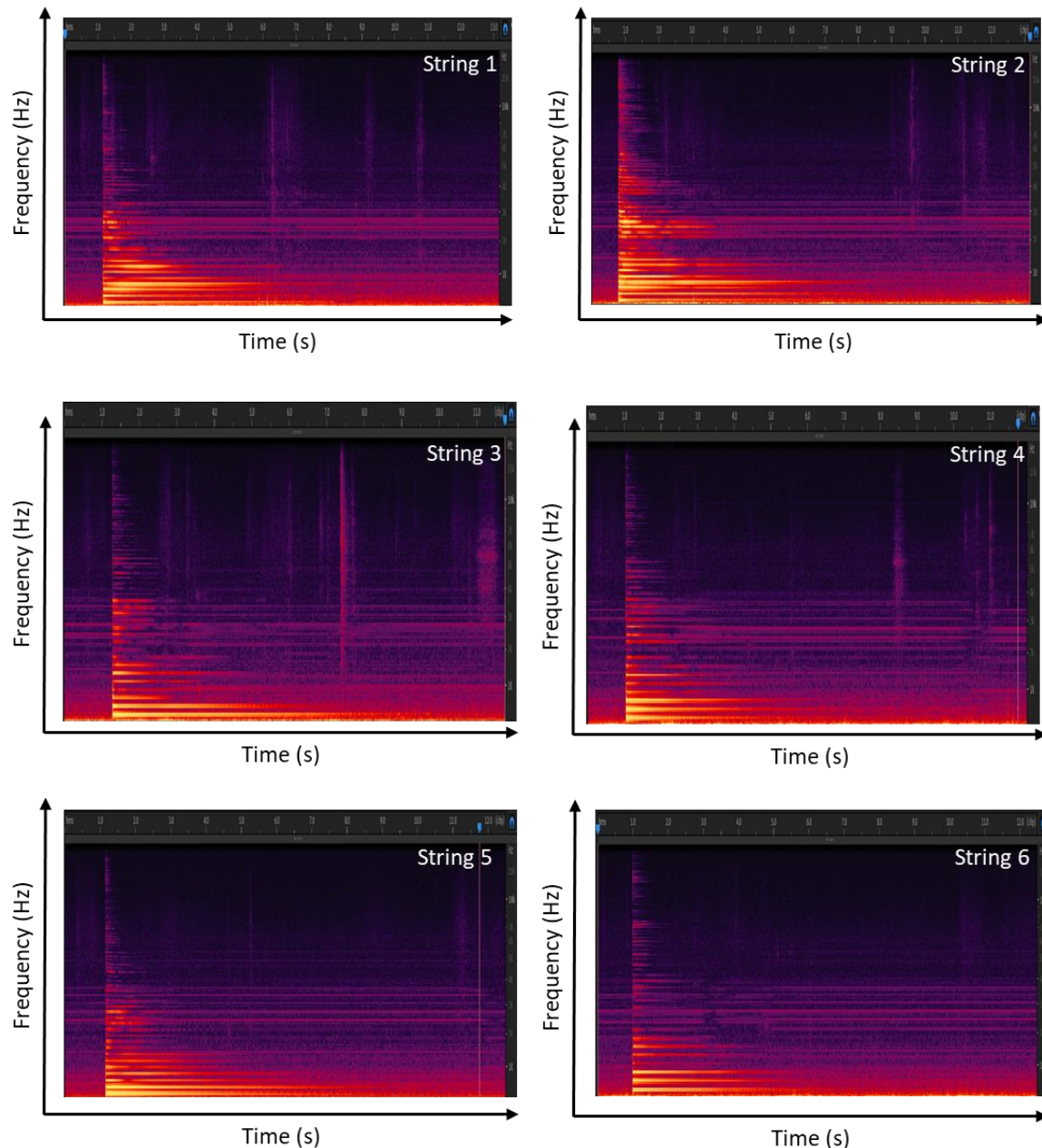
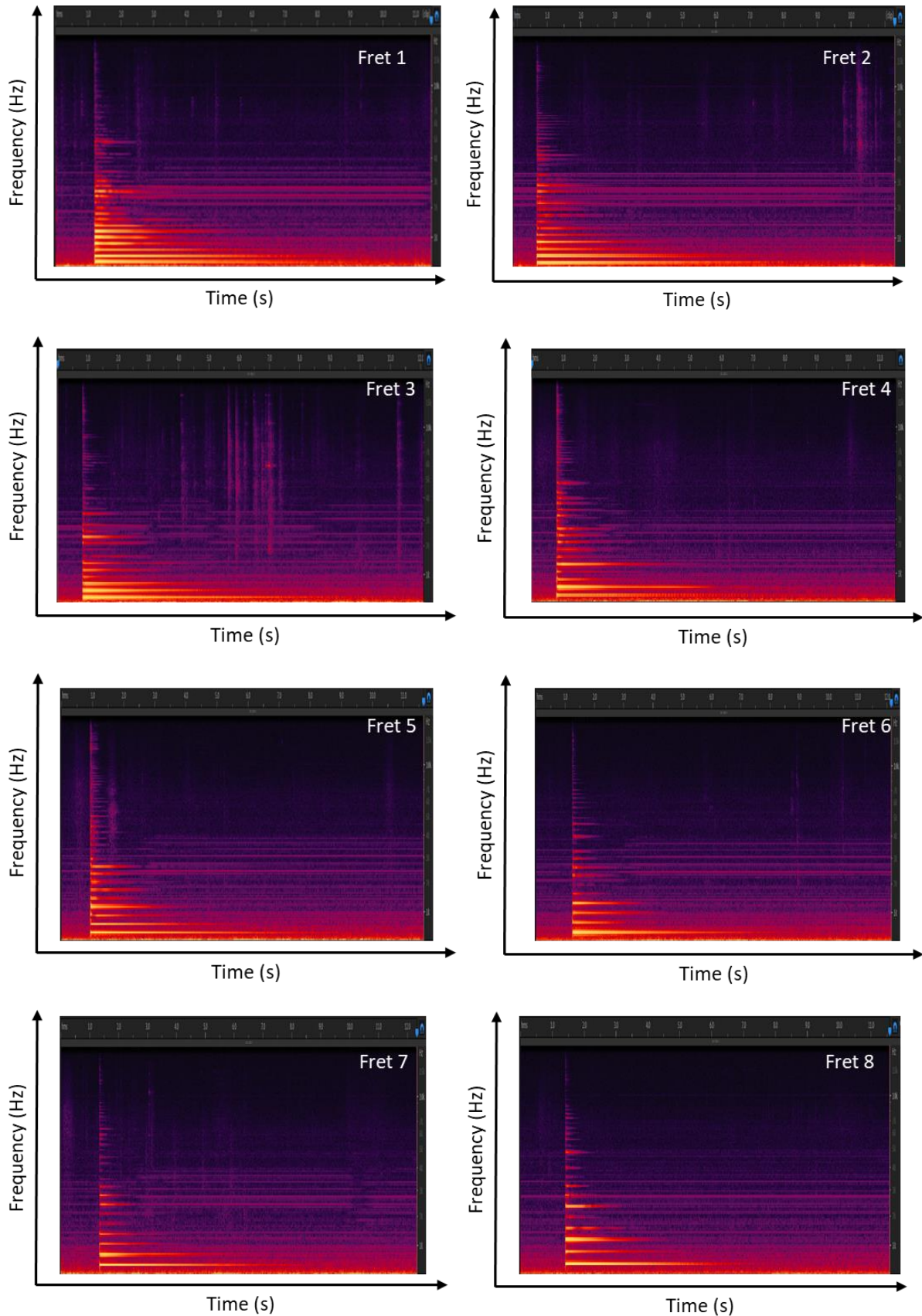
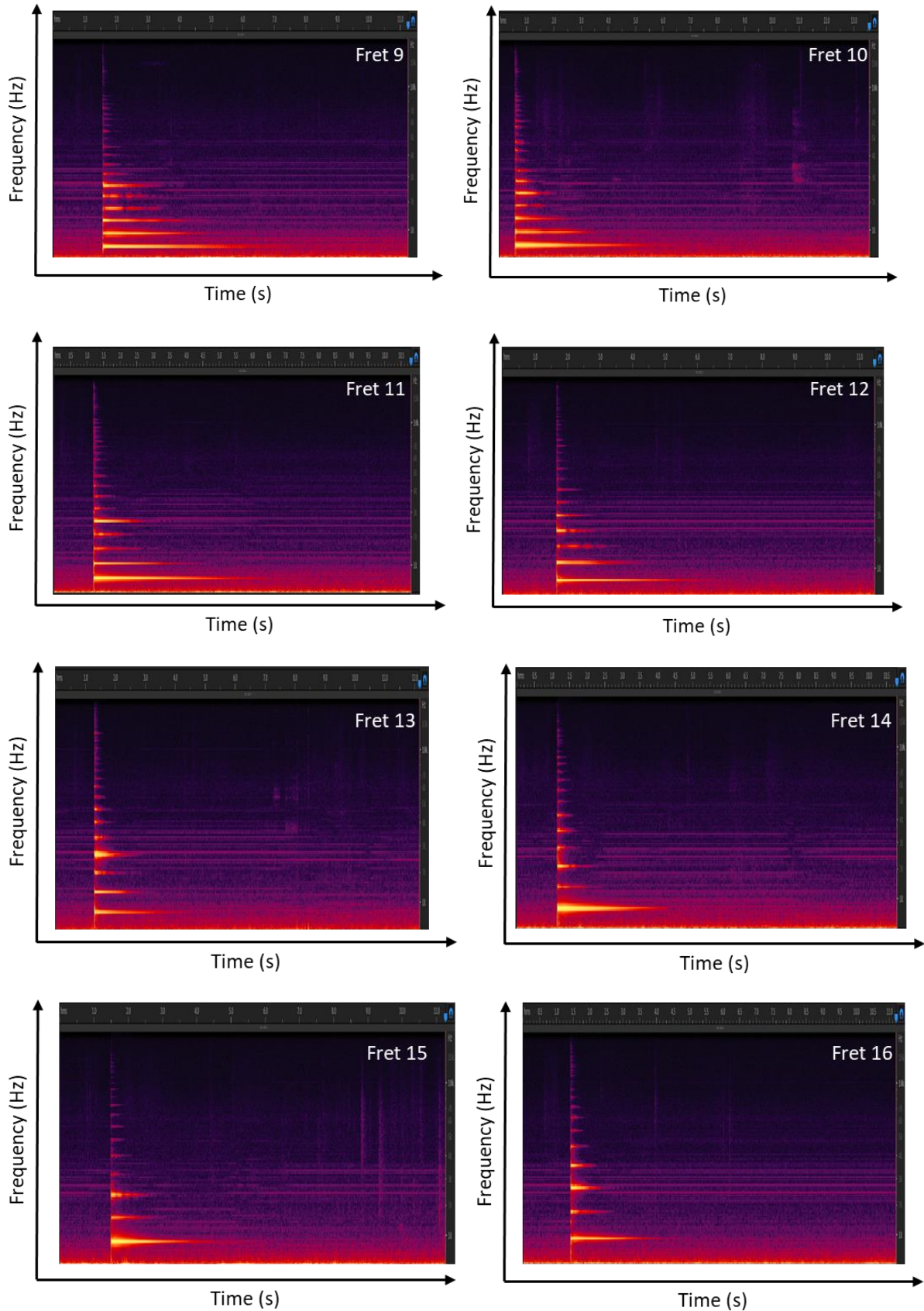

Fig. 5. The partials frequency versus time (TFA) for strings 1 through 6





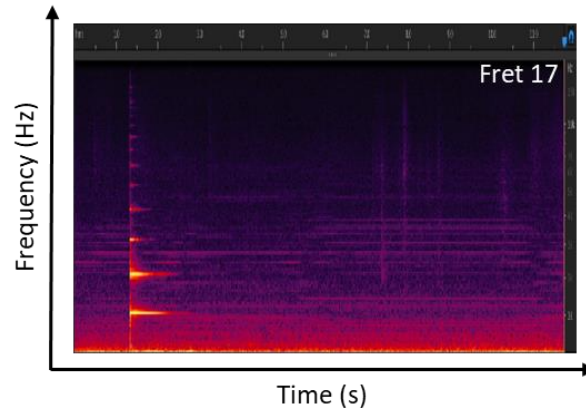

Fig. 6. The partials frequency versus time (TFA) for frets 1 through 17

CONCLUSIONS

1. This sape signals features were represented by the frequency spectrum and time frequency plane. The spectrum of each string was classified based on parameterising the frequency spectrum. Although these features are efficient, the information on time domain are missing.
2. Using the time varying frequency, the time frequency analysis (TFA) features were classified better than the frequency spectrum. The extraction of TFA performed at different frequencies give the time resolutions whereas the frequency content in the Table 1 only makes comparisons with the harmonics.
3. The PicoScope provides the partial frequencies, whereas TFA shows the region on the vertical axis that explains its duration. The peaks are harmonic, since they are integral multiples of the fundamental, whereas TFA describes the sound in the time frequency plane (the frequency is very distinct to differentiate the strength of the overtone frequencies). The fundamental and harmonics will be helpful for sape classification.

ACKNOWLEDGEMENTS

The authors are grateful to Universiti Malaysia Sarawak for the financial and technical support. The authors would like to thank Mr. Charles Erwin Ah Beng from Unit Kebudayaan dan Kesenian UNIMAS for all the support provided in the smooth conduct of this research.

REFERENCES CITED

- Deng, J. D., Simmermacher, C., and Cranefield, S. (2008). "A study on feature analysis for musical instrument classification," *IEEE Transactions on Systems, Man, and Cybernetic, Part B (Cybernetics)* 38(2), 429-438. DOI: 10.1109/TSMCB.2007.913394

- Essid, S., Richard, G., and David, B. (2006). "Instrument recognition in polyphonic music based on automatic taxonomies," *IEEE Transactions on Audio, Speech, and Language Processing* 14(1), 68-80. DOI: 10.1109/TSA.2005.860351
- Hamdan, S., Musoddiq, I. A., Musib A. F. and Sawawi, M. (2020). "Time frequency analysis of peking gamelan," *Pertanika J. Sci. & Technol.* 28(2), 441-457.
- Hamdan, S., Musib A. F., Sawawi, M. and Othman S. H. (2021). "The frequency spectrum and time frequency analysis of different violins classification as tools for selecting a good-sounding violin," *Wacana Seni Journal of Arts Discourse* 20, 27-40. DOI: 10.21315/ws2021.20.3
- Hamdan, S., Mohamad Said K. S. Rahman M. R., Sawawi M., Sinin A.E. (2023). "Gambus Hadhramaut: The Malaysian malay lute tuning retrieval," *BioResources* 18(2), 3387-3399. DOI:10.15376/biores.18.2.3387-3399
- Herrera-Boyer, P., Klapuri, A., and Davy, M. (2006). "Automatic classification of pitched musical instrument sounds," in: *Signal Processing Methods for Music Transcription*, A. Klapuri and M. Davy (eds.), Springer, Boston, MA, USA, pp. 163-200, DOI: 10.1007/0-387-32845-9_6
- Herrera-Boyer, P., Peeters, G., and Dubnov, F. (2003). "Automatic classification of musical instrument sounds," *Journal of New Music Research* 32(1), 3-21. DOI: 10.1076/jnmr.32.1.3
- Klapuri, A., and Davy, M. (eds.) (2006). *Signal Processing Methods for Music Transcription*, Springer, Boston. DOI: 10.1007/0-387-32845-9
- Lin, C. C., Chen, S. H., and Truong, T. K. (2005). "Audio classification and categorization based on wavelets and support vector machine," *IEEE Transactions on Speech and Audio Processing* 13(5), 644-651. DOI: 10.1109/TSA.2005.851880
- Plomp, R. (1976). *Aspects of Tone Sensation: A Psychophysical Study*, Academic Press, London.
- Wieczorkowska, A. A., and E. Kubera (2009). "Identification of a dominating instrument in polytimbral same-pitch mixes using SVM classifiers with non-linear kernel," *Journal of Intelligent Information Systems* 34, 275-303. DOI: 10.1007/s10844-009-0098-3
- Wong, T. H., Chang, J. H. W., Chee, F. P., and Dayou, J. (2017). "Effects of string tension to fundamental frequency of sound and body vibration of sape," *Transactions on Science and Technology* 4(4), 437-441.
- Wong, T. H., and Dayou, J. (2019). "Effects of plucking force to fundamental frequency of sound and body vibration of sape," *Journal of Social Science and Humanities* 16(3), 1-9.
- Wong, T. H., Batahong, R. Y., and Dayou, J. (2022). "Fretting effect on the fundamental sound frequency of sape," *Borneo Journal of Sciences & Technology* 4(1), 18-25.

Article submitted: April 5, 2023; Peer review completed: June 11, 2023; Revised version received: July 10, 2023; Accepted: July 25, 2023; Published: August 3, 2023.

DOI: 10.15376/biores.18.4.6761-6771